

APT2X30D40J 400V 30A
APT2X31D40J 400V 30A

DUAL DIE ISOTOP® PACKAGE

ULTRAFast SOFT RECOVERY DUAL RECTIFIER DIODES

PRODUCT APPLICATIONS	PRODUCT FEATURES	PRODUCT BENEFITS
<ul style="list-style-type: none"> • Anti-Parallel Diode <ul style="list-style-type: none"> -Switchmode Power Supply -Inverters • Free Wheeling Diode <ul style="list-style-type: none"> -Motor Controllers -Converters • Snubber Diode • Uninterruptible Power Supply (UPS) • Induction Heating • High Speed Rectifiers 	<ul style="list-style-type: none"> • Ultrafast Recovery Times • Soft Recovery Characteristics • Popular SOT-227 Package • Low Forward Voltage • High Blocking Voltage • Low Leakage Current 	<ul style="list-style-type: none"> • Low Losses • Low Noise Switching • Cooler Operation • Higher Reliability Systems • Increased System Power Density

MAXIMUM RATINGS

All Ratings: $T_C = 25^\circ\text{C}$ unless otherwise specified.

Symbol	Characteristic / Test Conditions	APT2X30/2X31D40J	UNIT
V_R	Maximum D.C. Reverse Voltage	400	Volts
V_{RRM}	Maximum Peak Repetitive Reverse Voltage		
V_{RWM}	Maximum Working Peak Reverse Voltage		
$I_F(AV)$	Maximum Average Forward Current ($T_C = 105^\circ\text{C}$, Duty Cycle = 0.5)	30	Amps
$I_F(RMS)$	RMS Forward Current	70	
I_{FSM}	Non-Repetitive Forward Surge Current ($T_J = 45^\circ\text{C}$, 8.3ms)	320	
T_J, T_{STG}	Operating and Storage Temperature Range	-55 to 150	$^\circ\text{C}$
T_L	Lead Temperature: 0.063" from Case for 10 Sec.	300	

STATIC ELECTRICAL CHARACTERISTICS

Symbol	Characteristic / Test Conditions	MIN	TYP	MAX	UNIT
V_F	Maximum Forward Voltage	$I_F = 30\text{A}$		1.5	Volts
		$I_F = 60\text{A}$		1.5	
		$I_F = 30\text{A}, T_J = 150^\circ\text{C}$		1.3	
I_{RM}	Maximum Reverse Leakage Current	$V_R = V_R$ Rated		250	μA
		$V_R = V_R$ Rated, $T_J = 125^\circ\text{C}$		500	
C_T	Junction Capacitance, $V_R = 200\text{V}$		52		pF
L_S	Series Inductance (Lead to Lead 5mm from Base)		10		nH

APT Website - <http://www.advancedpower.com>

USA
 405 S.W. Columbia Street
EUROPE

Avenue J.F. Kennedy Bât B4 Parc Cadéra Nord

Bend, Oregon 97702-1035

F-33700 Merignac - France

Phone: (541) 382-8028

Phone: (33) 5 57 92 15 15

FAX: (541) 388-0364

FAX: (33) 5 56 47 97 61

DYNAMIC CHARACTERISTICS

APT2X30/2X31D40J

Symbol	Characteristic	MIN	TYP	MAX	UNIT
t_{rr1}	Reverse Recovery Time, $I_F = 1.0A$, $di_F/dt = -15A/\mu s$, $V_R = 30V$, $T_J = 25^\circ C$		45	65	ns
t_{rr2}	Reverse Recovery Time		45		
t_{rr3}	$I_F = 30A$, $di_F/dt = -240A/\mu s$, $V_R = 240V$		70		
t_{fr1}	Forward Recovery Time		150		
t_{fr2}	$I_F = 30A$, $di_F/dt = 240A/\mu s$, $V_R = 240V$		150		
I_{RRM1}	Reverse Recovery Current		6	10	Amps
I_{RRM2}	$I_F = 30A$, $di_F/dt = -240A/\mu s$, $V_R = 240V$		10	18	
Q_{rr1}	Recovery Charge		135		nC
Q_{rr2}	$I_F = 30A$, $di_F/dt = -240A/\mu s$, $V_R = 240V$		350		
V_{fr1}	Forward Recovery Voltage		3.2		Volts
V_{fr2}	$I_F = 30A$, $di_F/dt = 240A/\mu s$, $V_R = 240V$		3.2		
diM/dt	Rate of Fall of Recovery Current		500		A/ μs
	$I_F = 30A$, $di_F/dt = -240A/\mu s$, $V_R = 240V$ (See Figure 10)		500		

THERMAL AND MECHANICAL CHARACTERISTICS

Symbol	Characteristic / Test Conditions	MIN	TYP	MAX	UNIT
$R_{\theta JC}$	Junction-to-Case Thermal Resistance			0.90	$^\circ C/W$
$R_{\theta JA}$	Junction-to-Ambient Thermal Resistance			20	
$V_{Isolation}$	RMS Voltage (50-60 Hz Sinusoidal Waveform from Terminals to Mounting Base for 1 Min.)	2500			Volts
W_T	Package Weight		1.03		oz
			29.2		gm
Torque	Maximum Torque (Mounting = 8-32 or 4mm Machine and Terminals = 4mm Machine)			13.6	lb•in
				1.5	N•m

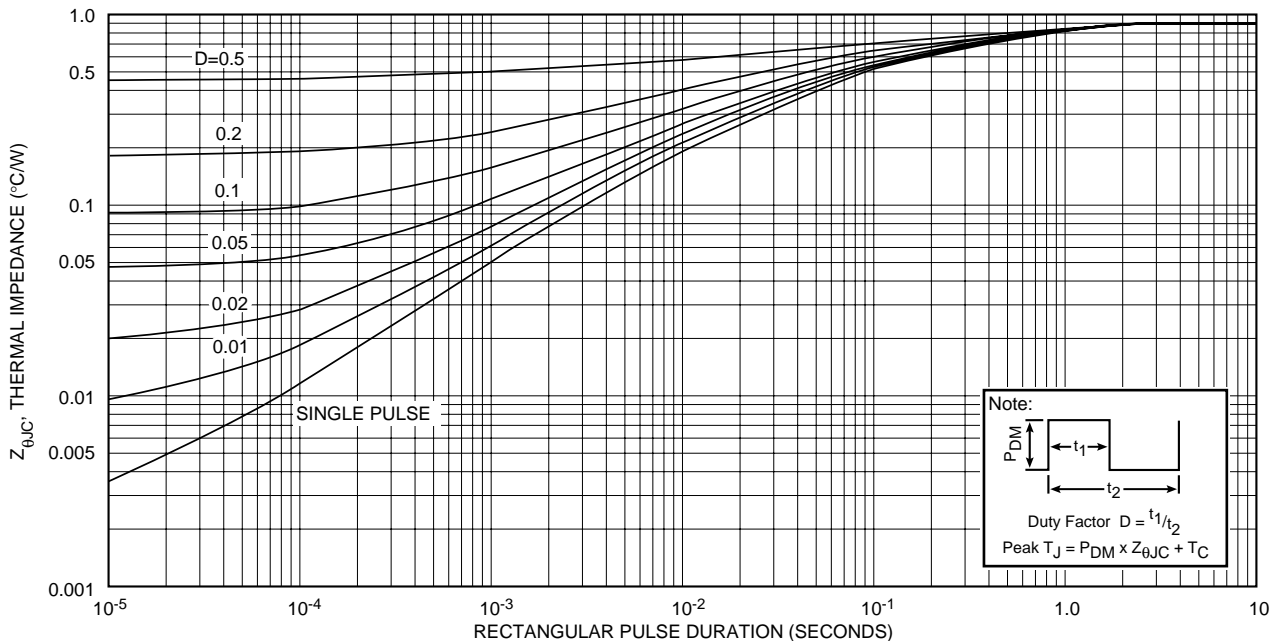

FIGURE 1, MAXIMUM EFFECTIVE TRANSIENT THERMAL IMPEDANCE, JUNCTION-TO-CASE vs PULSE DURATION

APT2X30/2X31D40J

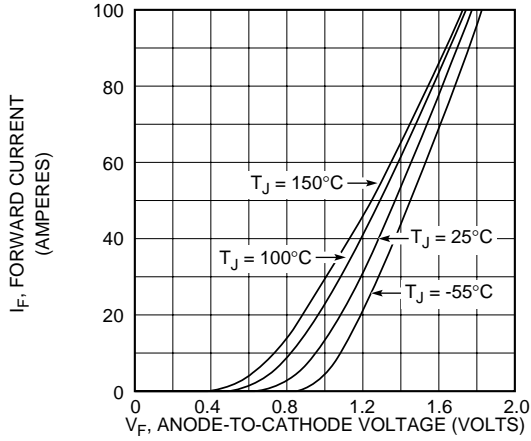

Figure 2, Forward Voltage Drop vs Forward Current

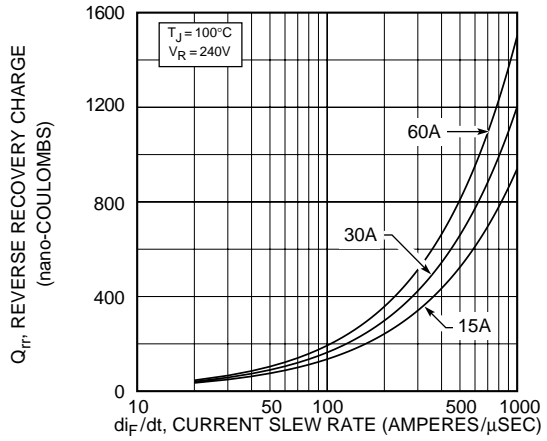

Figure 3, Reverse Recovery Charge vs Current Slew Rate

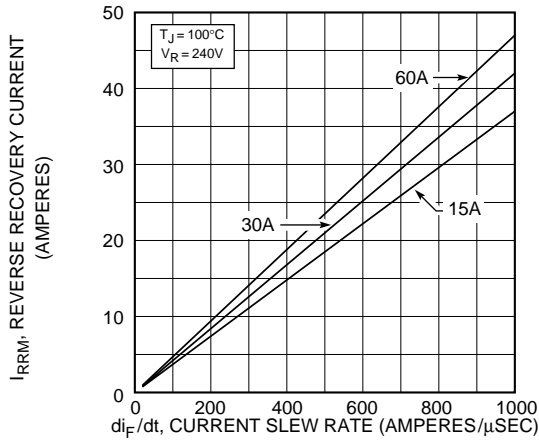

Figure 4, Reverse Recovery Current vs Current Slew Rate

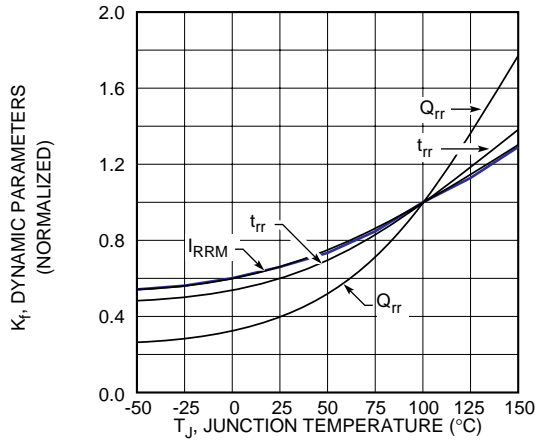

Figure 5, Dynamic Parameters vs Junction Temperature

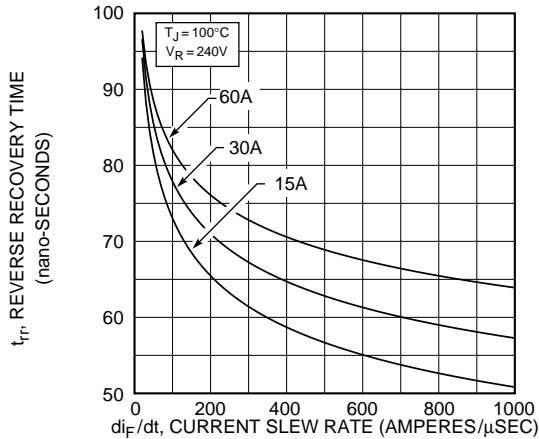

Figure 6, Reverse Recovery Time vs Current Slew Rate

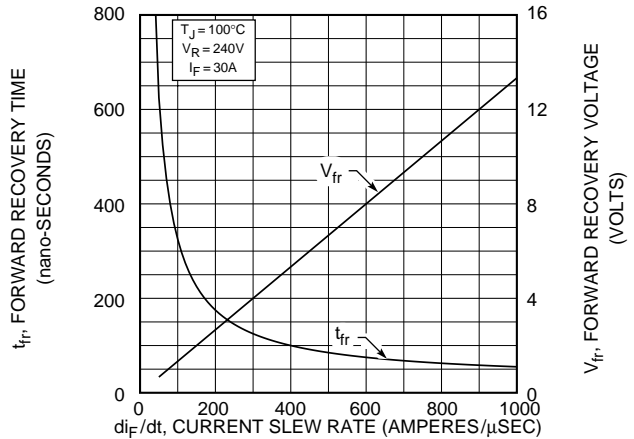

Figure 7, Forward Recovery Voltage/Time vs Current Slew Rate

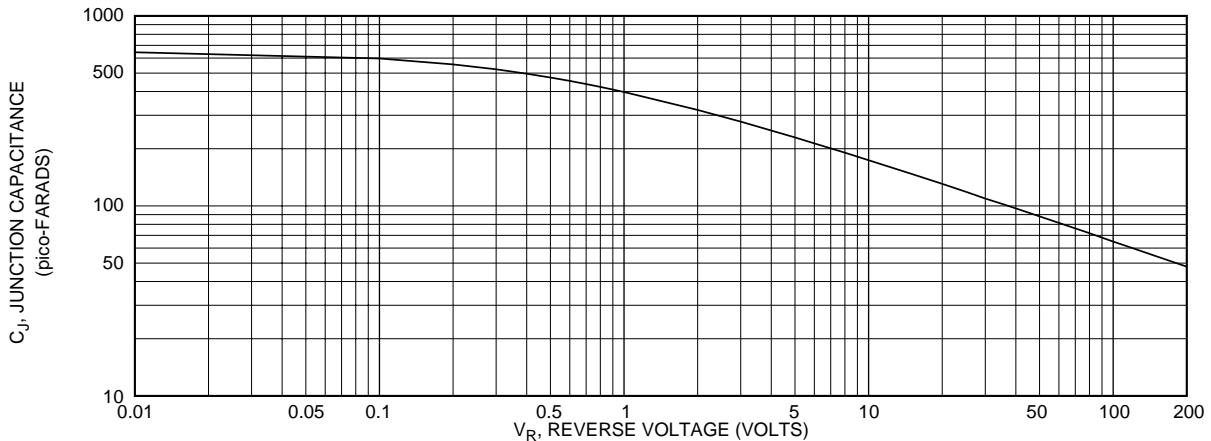

Figure 8, Junction Capacitance vs Reverse Voltage

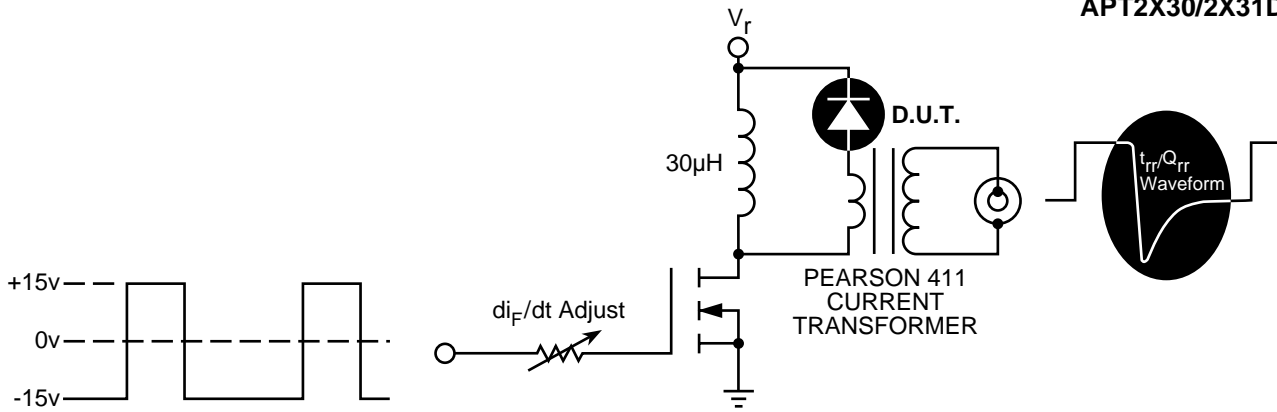

Figure 9, Diode Reverse Recovery Test Circuit and Waveforms

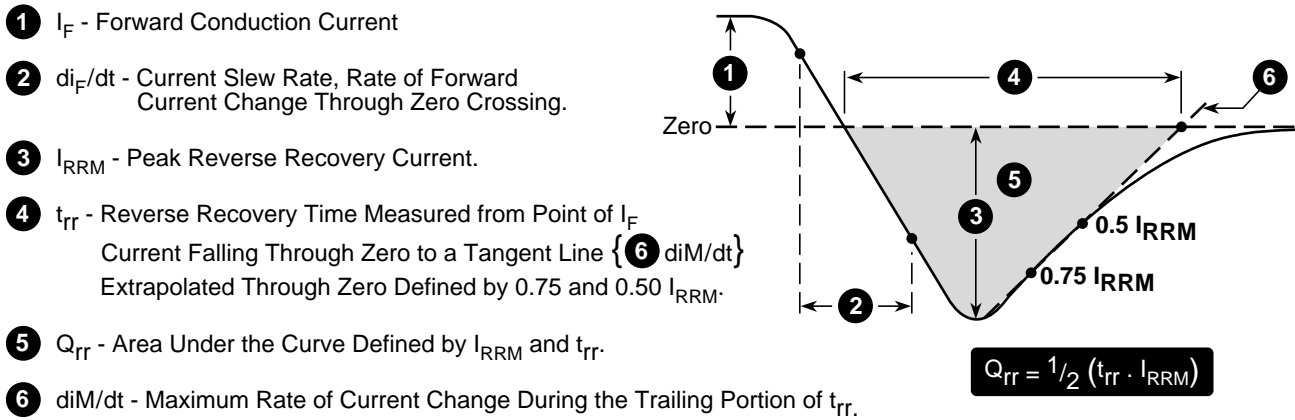

Figure 10, Diode Reverse Recovery Waveform and Definitions

APT Reserves the right to change, without notice, the specifications and information contained herein.

SOT-227 Package Outline

